

Destiny

Residential Elevator

Design Guide



ASME A17.1 - 2004
Part 5.3

National
Wheel·O·Vator

Table of Contents

	Page #
Equipment	3
Typical Hoistway Layouts	4,5
Recommended Hoistway Construction	6
Hydraulic Drive Machine Room Layout	7
RMR (Reduced Machine Room) Layout	8
RMD (Rail Mount Drum) Layout	9
Typical Electrical Space Layout For RMD	10
Compact Machine Room Layout For RMR.....	10
Specifications	11-14

Introduction:

Our Design Guide was created to assist the architect and builder by providing a guide to incorporate a ***Destiny*** residential elevator into a new or existing home.

When planning for your ***Destiny*** residential elevator, the following questions need to be answered:

- Do you meet local, state and national code requirements?
- What are your hoistway and car size requirements?
- Have you planned for a machine room and the electrical requirements?

National Wheel-O-Vator is dedicated to providing our partners unequalled value by offering products of the highest quality, complimented by unrivaled customer service.

Equipment

General:

- Travel: Up to 50'
- Load capacity:
 - Roped Hydraulic Drive - 950 lbs up to 44' (750 lbs opt.)
 - Winding Drum Drive - 950 lbs (750 lbs opt.)
- Speed: 36 fpm (optional 40 fpm)
- Overhead: 96" minimum: (RMD 111" min.)
- Pit depth: 6" minimum (8" recommended)

Choice of Drive Systems:

- Roped Hydraulic Drive
 1. 1:2 roped hydraulic.
 2. Remote machine room can be located up to 40' from the unit.
 3. 3HP submerged motor with 2-speed valve assembly.
- Winding Drum Drive
 1. 3HP Inverter controlled winding drum unit.
 2. RMD (Rail Mount Drum), RMR (Reduced Machine Room), plus other varieties of drum layout configurations.

Standard Features:

- Car size: Up to 15 sq.ft.
- 7'3" interior ceiling height
- No.4 (brushed) stainless steel or No.4 (brushed) brass hall call and car operating panel
- Wood handrail
- Light oak, dark oak or white melamine interior walls
- Birch, oak, or maple veneer interior walls
- Gate
- Single globe light
- White melamine, oak veneer, birch veneer, or maple veneer ceiling
- Unfinished plywood floor
- Sill set for 1/4" finished floor
- Telephone jack - surface mount
- Digital floor position indicator
- "Car Here" and call acknowledgement lights
- Automatic on/off car lighting
- Emergency stop switch and alarm button
- Emergency lighting
- Self Diagnostic System

- Pit switch
- Manual lowering device
- Pre-wired car • Two stops
- Auto- homing
- Single opening
- Three year limited parts warranty

Optional Features:

- Custom car size
- Custom car heights
- Custom fixtures
- No.8 (polished) brass or No.8 (polished) stainless steel hall call, car operation panel and phone box
- Custom interior wood veneer choices: cherry, hickory, etc.
- Custom color or material scissor gate
- Raised or recessed panel car - birch, red oak, cherry, maple or hickory
- Vaulted ceiling in matching hardwood
- Auto gate operator (accordion gate only) with battery backup
- Finished flooring - light oak or dark oak
- Three to six stops
- Recessed down lights
- Handrail
 1. No.4 (brushed) brass
 2. No.8 (polished) brass
 3. No.4 (brushed) stainless steel
 4. No.8 (polished) stainless steel

Typical Hoistway Layouts

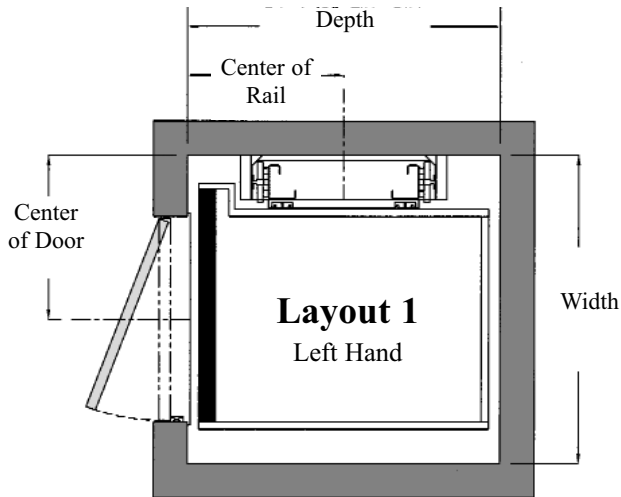

Left Hand Rail/Right Hand Door

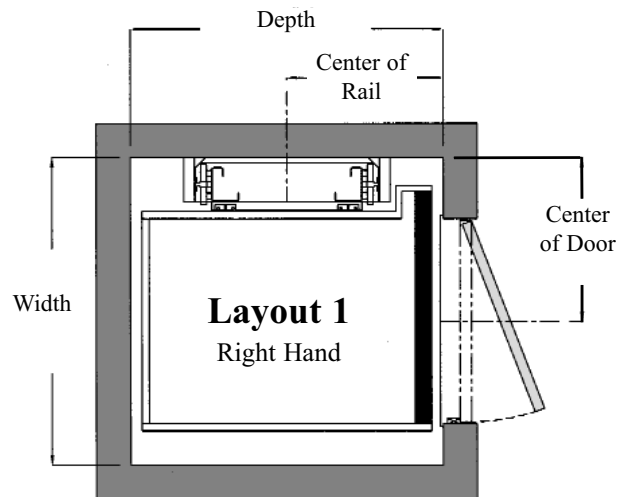

Right Hand Rail/Left Hand Door

Car Size	Width	Depth	Center of Rail	Center of Door
36" x 48"	54"	54 1/2"	27 1/4"	28 3/4"
36" x 48"	51 1/2"	54"	27 1/4"	28 3/4"
Compact Hoistway				
42" x 48"	59"	54 1/2"	27 1/4"	34 3/4"
36" x 60"	54"	66 1/2"	33 1/4"	28 3/4"
40" x 54"	57"	60 1/2"	30 1/4"	32 3/4"

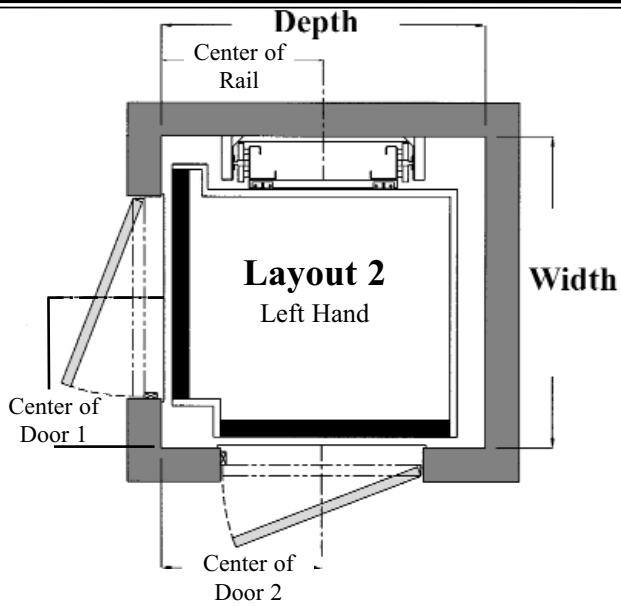

90 Deg. Car
Left Hand Door/Right Hand Door

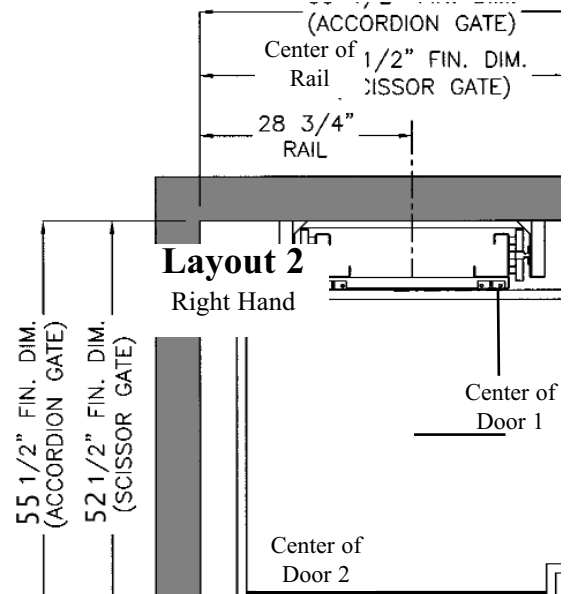

90 Deg. Car
Right Hand Door/Left Hand Door

Car Size	Width	Depth	Center of Rail	Center of Door 1	Center of Door 2
40" x 48"	54 3/4"	57 1/2"	27 1/4"	25 1/2"	28"
42" x 48"	56 3/4"	57 1/2"	27 1/4"	25 1/2"	28"
40" x 60"	54 3/4"	69 1/2"	33 1/4"	25 1/2"	40"
40" x 54"	54 3/4"	63 1/2"	30 1/4"	25 1/2"	34"

Typical Hoistway Layouts

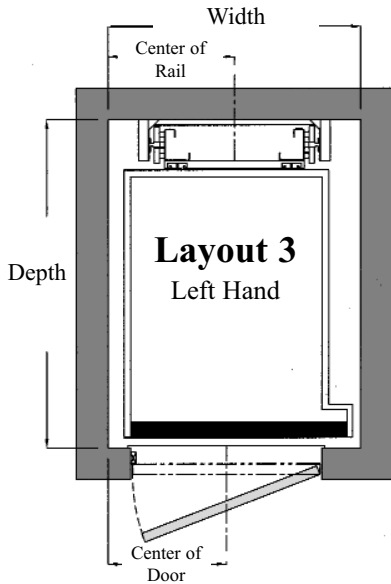

Front Rail/Left Hand Door

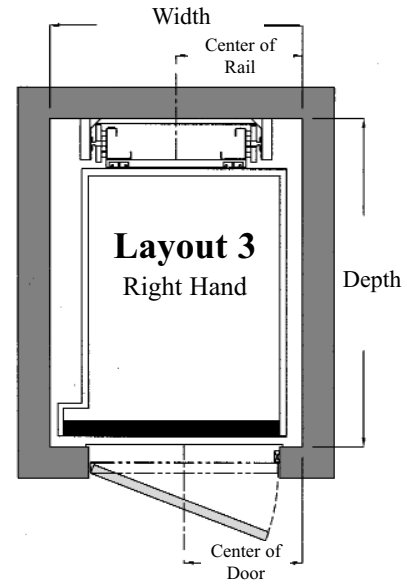

Front Rail/Right Hand Door

Car Size	Width	Depth	Center of Rail	Center of Door
36" x 48"	47 1/2"	62 1/2"	23 3/4"	22 1/4"
42" x 48"	51 1/2"	62 1/2"	25 3/4"	22 1/4"
36" x 60"	47 1/2"	74 1/2"	23 3/4"	22 1/4"
40" x 54"	50 1/2"	68 1/2"	25 1/4"	22 1/4"

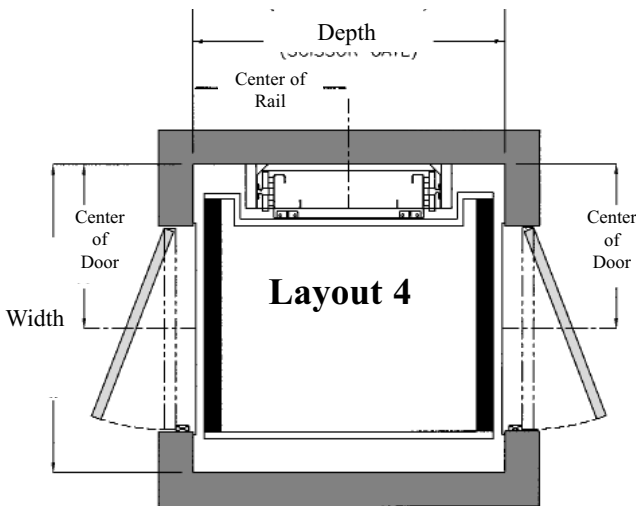

Opposite Opening Car
Right Hand Door/Left Hand Door

Car Size	Width	Depth	Center of Rail	Center of Door
36" x 48"	54"	54 1/2"	27 1/4"	28 3/4"
36" x 48" Compact Hoistway	51 1/2"	54 1/2"	27 1/4"	28 3/4"
42" x 48"	59"	54 1/2"	27 1/4"	34 3/4"
36" x 60"	54"	66 1/2"	33 1/4"	28 3/4"
40" x 54"	57"	60 1/2"	30 1/4"	32 3/4"

Dimensions are from the inside finished hoistway and calculated using 1 1/4" car wall thickness. Please contact your local dealer for more information on our custom car sizes.

We recommend the handing of the car gates to be the same as the hoistway door. The car doors can be either hand, but this handing must be consistent on every level. Changing the door swing may affect hoistway dimensions. Contact your local representative or National Wheel-O-Vator for more details on our car sizes.

Recommended Hoistway Construction

(2) 2x10 laminated, supported and fastened between (2) 2x4 behind gypsum board for supporting rail brackets

* Stud at center line of rail aids bracket alignment

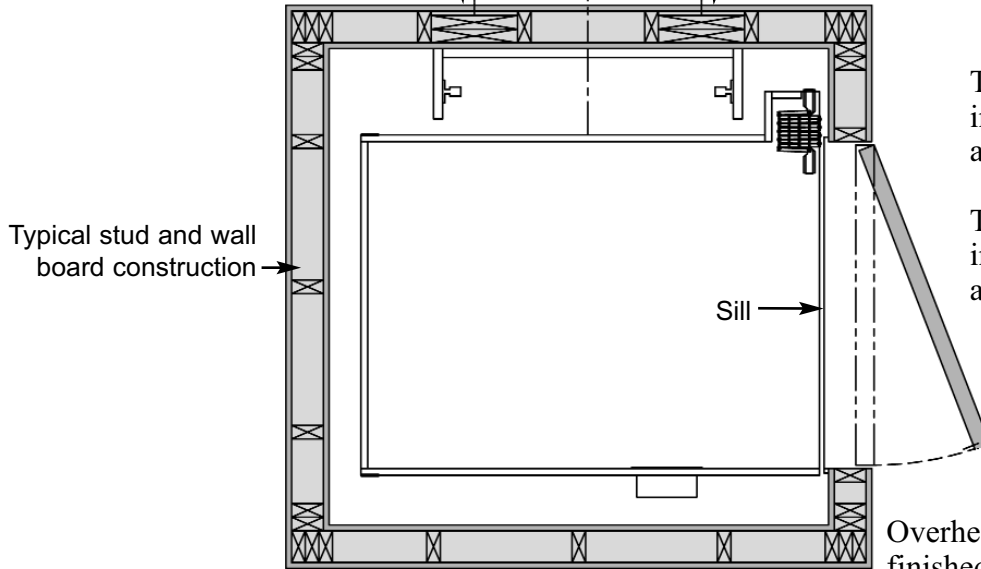

The max. distance between the inside face of the hoistway door and the hoistway sill is 3".

The max. distance between the inside face of the hoistway door and the car gate is 5".

Overhead Clearance Requirements (from finished top floor) = Car height + 9"

Rail Reactions

750#	950#
R1 = 150	R1 = 175
R2 = 400	R2 = 450

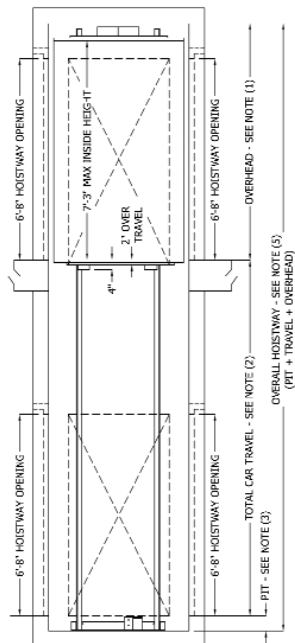
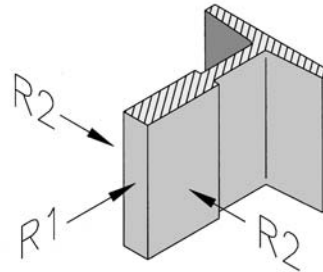

Impact Load @ Pit
 4300 lbs (750# Capacity)
 4650 lbs (950# Capacity)

Static Load @ Pit
 2675 lbs (750# Capacity)
 2700 lbs (950# Capacity)

Hydraulic Drive Machine Room Layout

Standard Machine Room Layout

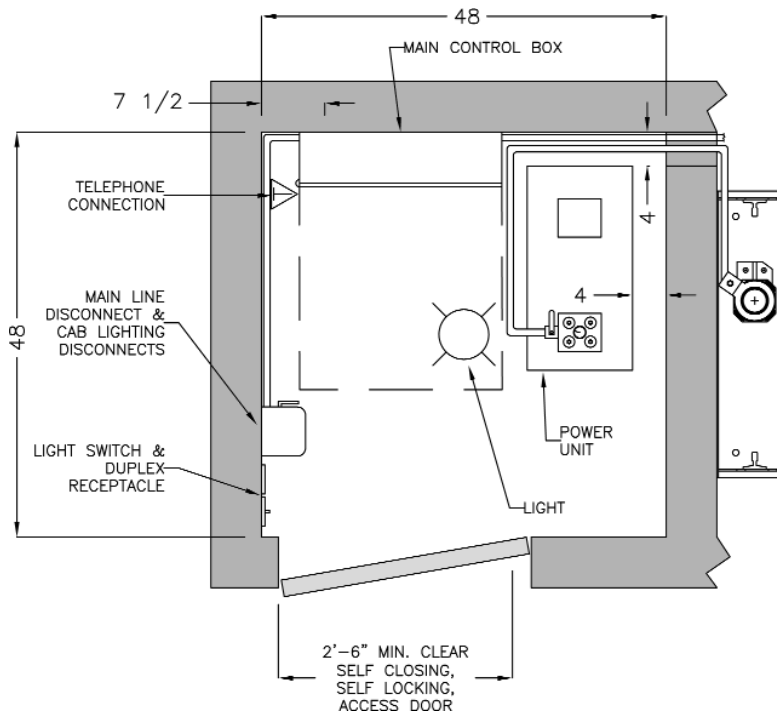

Machine room must meet local, state and national codes.

Main control box measurement:
24"H x 24"W x 8"D

Power unit measurement:
35"H x 24 1/4"W x 12 1/2"D

Work space required in front of the disconnects and main control box:
30"W x 36"D

Other material needed:

- Telephone connection
- Main line disconnect
- Car lighting disconnect
- Light switch and G.F.I. duplex receptacle
- Access door
- Light
- Main control box backing (if required)

Compact Machine Room Layout

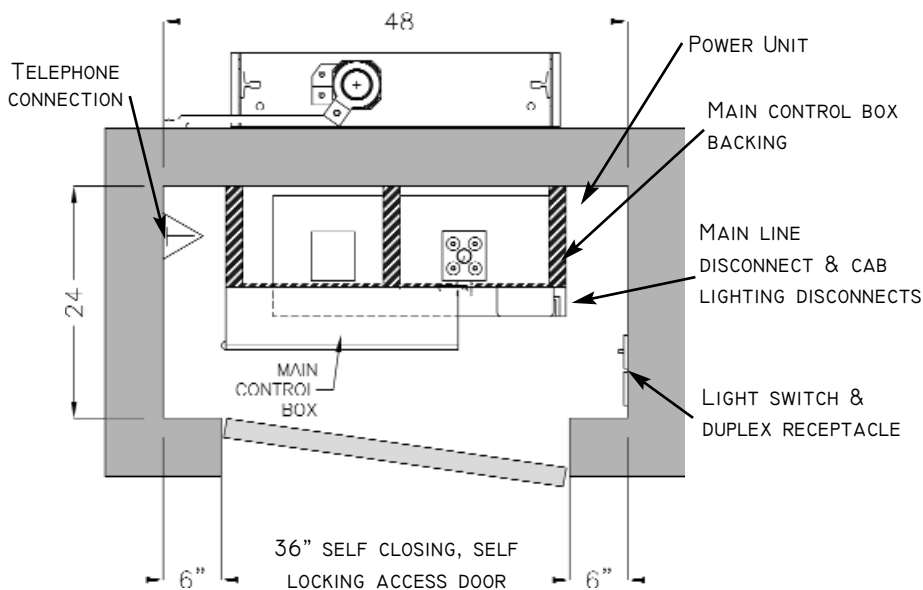

Overhead View

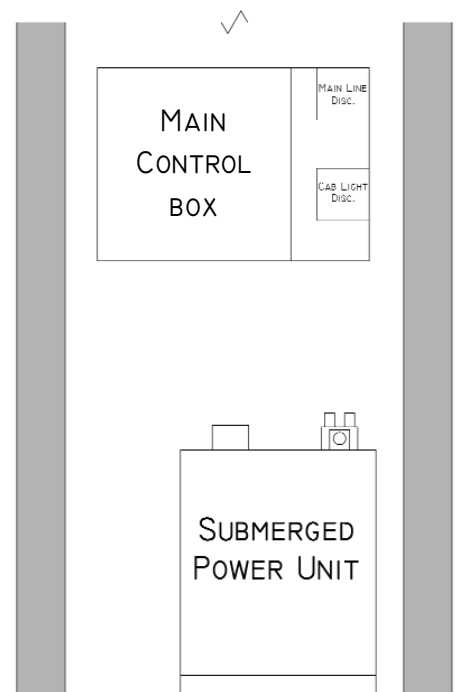

Front View

RMR (Reduced Machine Room) Layout

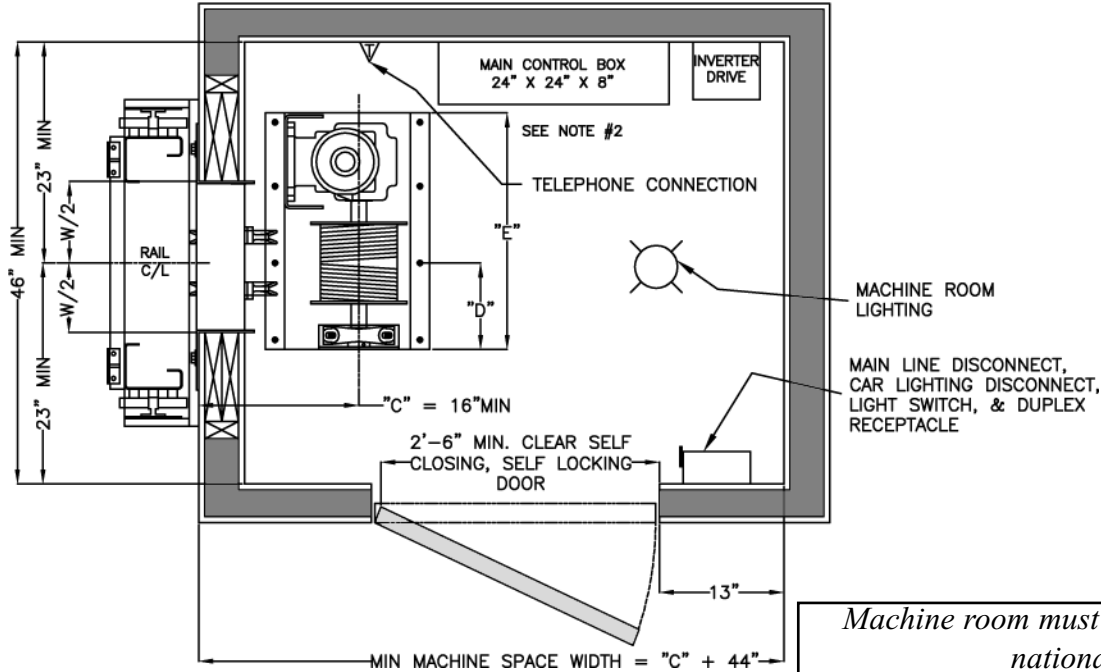

Machine room must meet local, state and national codes.

Main Control Box measurement:
24" H x 24" W x 8" D

Optional battery lowering box measurement:
16" H x 16" W x 6" D

Work space required in front of the disconnects and main control box:
30" W x 36" D

4" concrete slab required

Other materials needed:

- Telephone connection
- Main line disconnect
- Car lighting disconnect
- Light switch and G.F.I. duplex receptacle
- Access door
- Light

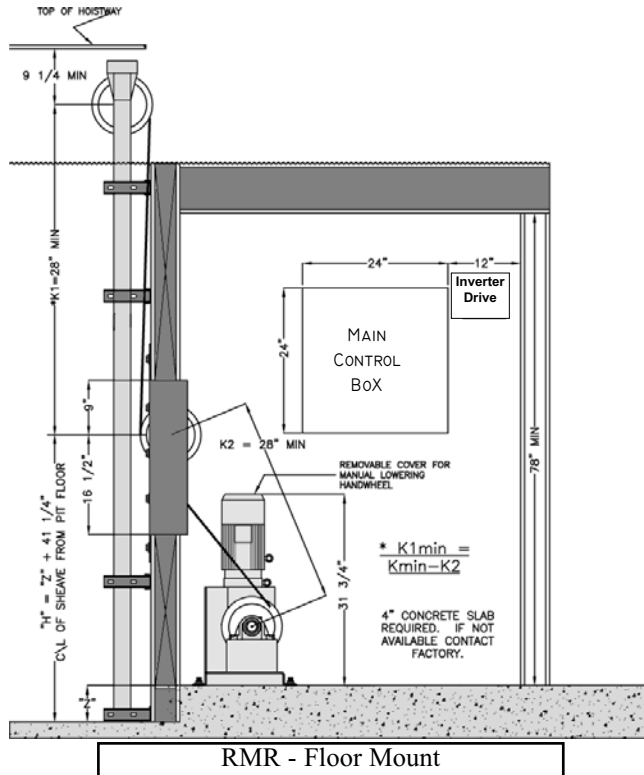

RMR Drum Chart

Max. Travel (In Feet)	8'	10'	12'	14'	16'	18'	20'	22'	24'	25'	27'	29'	31'	33'	35'	37'	39'	41'	43'	44'	46'	48'	50'
Starting Wraps	4	3	2	1	5	4	3	2	1	5	4	3	2	1	5	4	3	2	1	4	3	2	1
Kmin = (K1+K2) min	56"	56"	56"	56"	56"	56"	56"	56"	56"	56"	59"	66"	74"	81"	85"	92"	99"	106"	113"	116"	124"	131"	138"
Drum Length	8"			12"						16"						20"			23"				
Drum C/L "D"	8 3/4"			10 3/4"						12 3/4"						16 1/4"			16 1/4"				
Machine Base "E"	24 1/2"			28 1/2"						33 1/8"						39 1/2"			39 1/2"				
Wall Cutout Width "W"	17"			17"						17"						25"			25"				

RMD (Rail Mount Drum) Layout

By utilizing our RMD (Rail Mount Drum), you can eliminate the need for a machine room. (Per NEC, National Electrical Code, a separate electrical space may be required.) This winding drum layout provides the perfect solution for those applications where space is a problem. The drawings below show the drive system located in the attic and in the shaft. National Wheel-O-Vator offers a variety of mountings for the winding drum. Please contact us for more information.

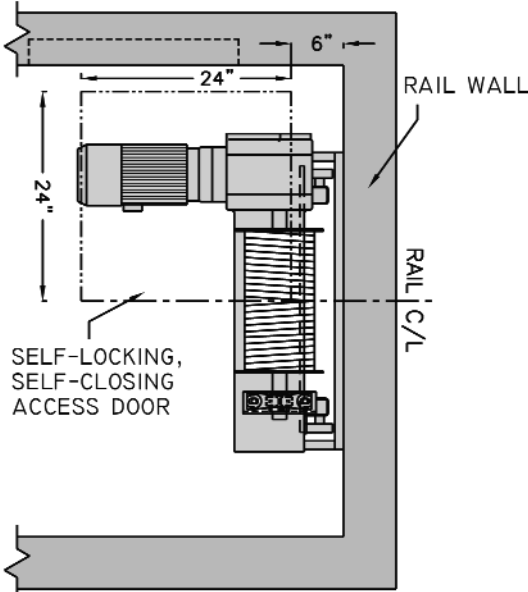

Overhead Shaft View

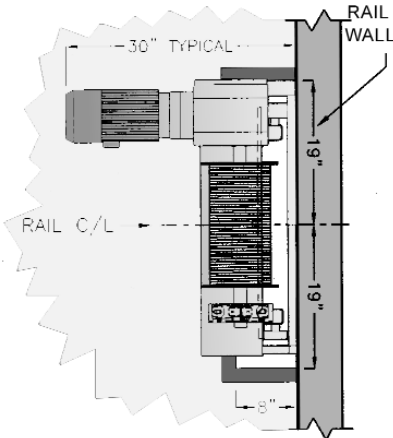

Overhead Attic View

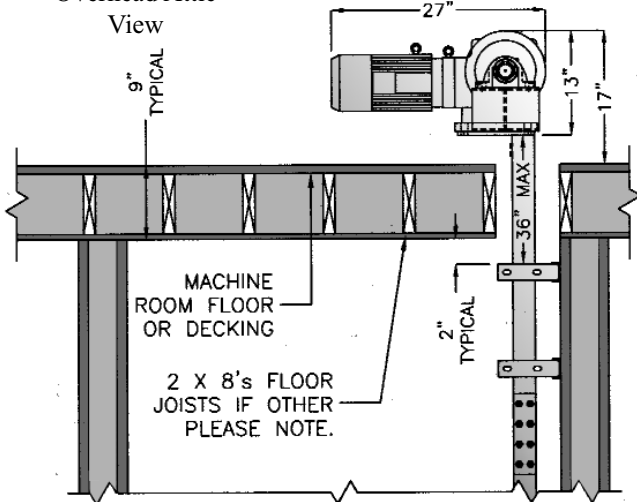
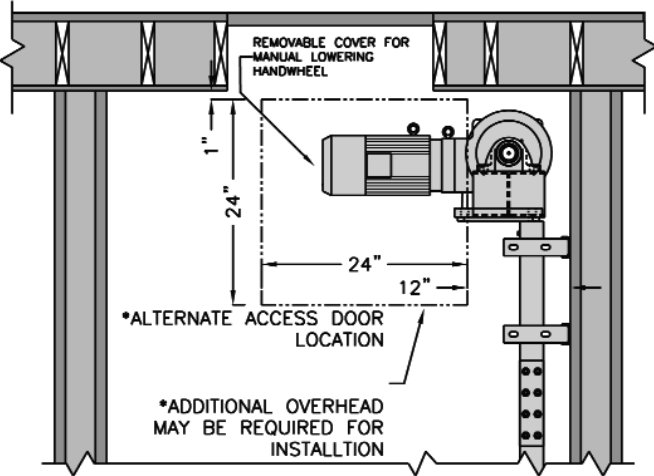

Typical Control Space Layout For RMD

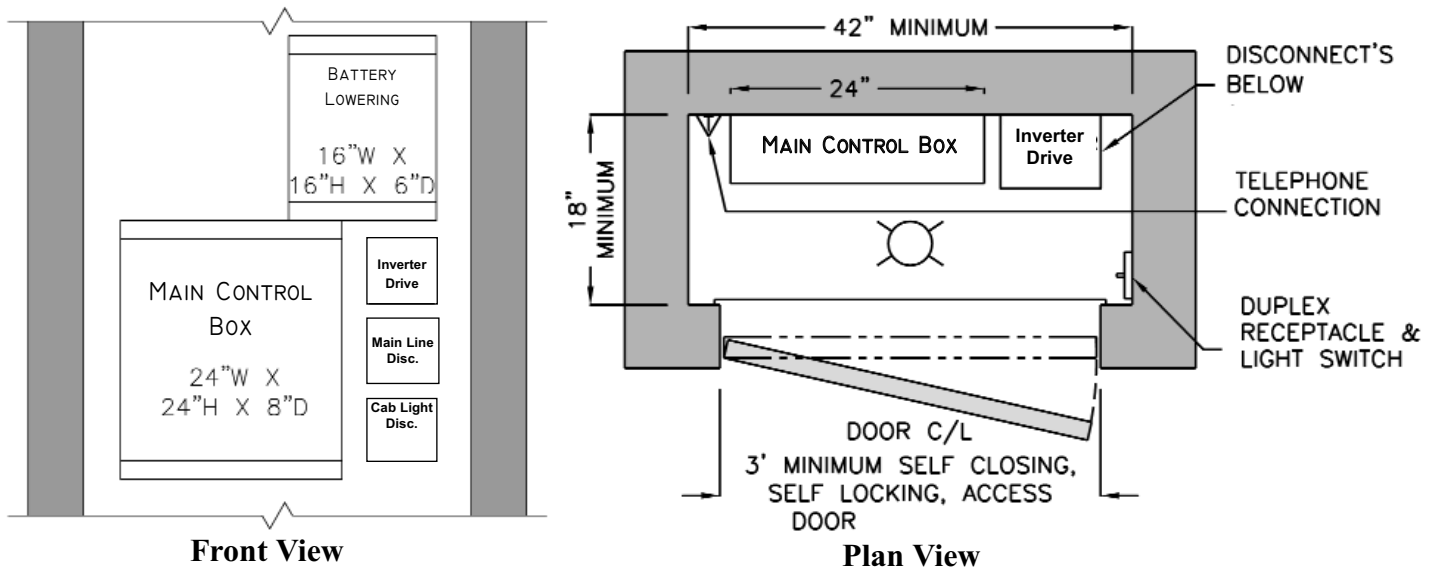

Compact Machine Room Layout For RMR

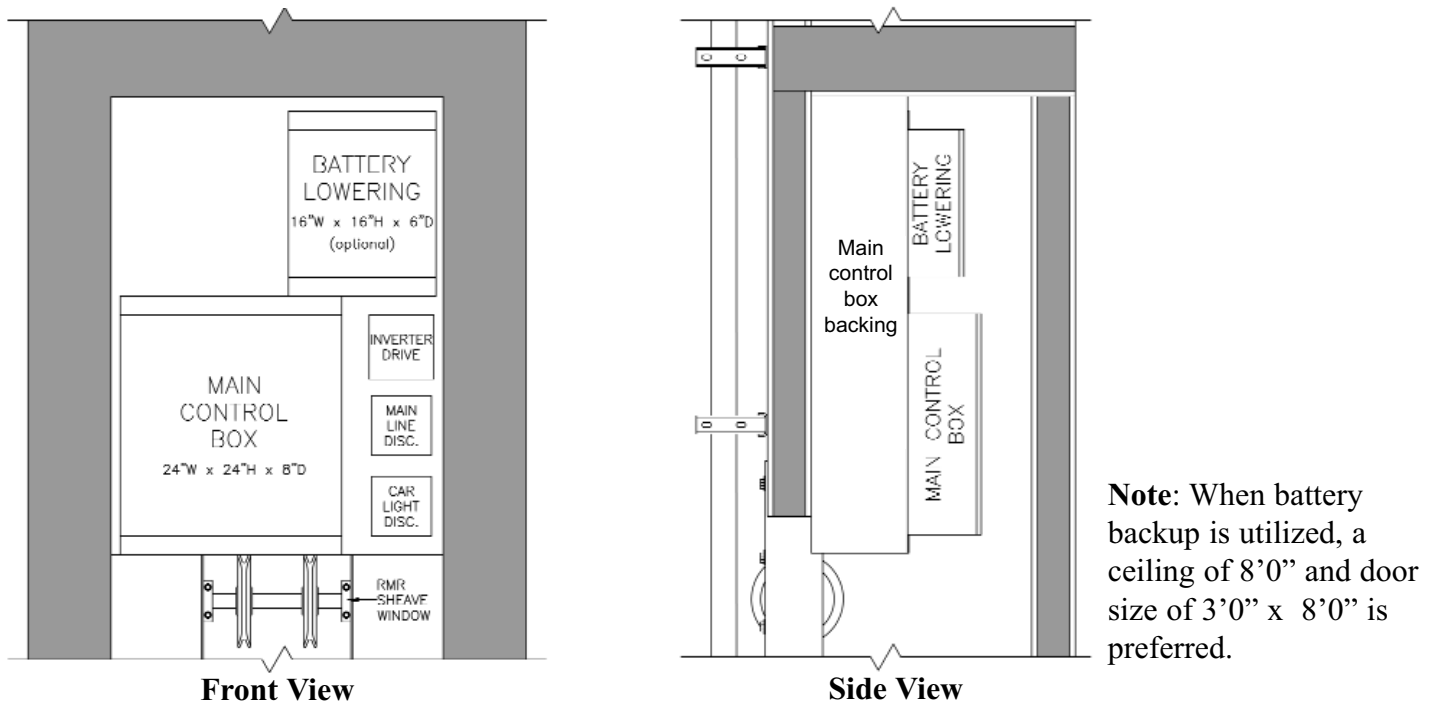

National Wheel-O-Vator's *Destiny* residential elevator will add value and convenience to every level of your home. From the elegant wood interior walls to the stylish lighting, this elevator car will compliment any decor. Your elevator car can be handcrafted in a variety of designs and wood finishes. Our assortment of accordion and scissors gates provide safety and enhance your *Destiny's* beauty. A choice of stainless steel or brass fixtures will add the finishing touch to your *Destiny* residential elevator. National Wheel-O-Vator is here to assist you in tailoring the *Destiny* to your own personal taste.

Please note: Plans and specifications are subject to change.

Part 1 General

1.01 SECTION INCLUDES

A. Residential elevator with 1:2 roped hydraulic lift system.

1.02 WORK INCLUDED

A. Furnish all labor and materials, equipment and incidentals necessary to assemble and erect a residential elevator, complete with a remote power unit and all hoses, rails, brackets, connections and controls essential for proper operation.

1.03 WORK BY OTHERS

A. Construct a hoistway of the size required by the manufacturer, complete with all demolition, additional framing, headers and framing components necessary to prepare the existing building to receive the elevator.

1. Hoistway size: Dependent upon car size.
2. The hoistway shall be vertical to within 1/8" throughout the entire height.
3. Provide structural members, installed, full length vertically of hoistway between floor plates per manufacturer's recommendation.
4. Pit requirements: Provide 8" deep pit (minimum 6" deep). Install reinforcement and concrete as necessary. Floor must sustain load specified in job drawings.

B. Construct a machine room:

1. Provide elevator electrical circuit: 208/230 volt AC/1 phase/60hz (30 amp).
2. Provide elevator lighting electrical circuit: 115 volt (15 amp).

C. Provide system to maintain hoistway and machine room temperature between 50-90 degrees Fahrenheit.

1.04 REFERENCES:

A. General: The applicable provisions of the following standards shall apply as if written here in their entirety.

B. American Society of Mechanical Engineers/American National Standards Institute (ASME/ANSI) publications: ASME/ANSI A17.1 "Safety Codes for Elevators and Escalators", Section 5.3.

C. National Fire Protection Association (NFPA) publications: NFPA 70 National Electrical Code.

1.05 SYSTEM DESCRIPTION:

- A. Travel: _____ (50' max)
- B. Stops: _____ (up to 6)
- C. Load capacity: 950 lb.up to 44' (750 lb. opt.)
- D. Speed: 36 fpm

1.06 SUBMITTALS

A. Submittals shall be in accordance with Section 01300, SUBMITTALS.

B. Product Data: Submit product data, including manufacturer's specifications.

C. Shop Drawings:

1. Shop drawings showing all field construction, including dimensions.
2. Hoistway dimensions.
3. Wiring diagrams.
4. Maintenance instructions.
5. Car and gate selection charts.

1.07 QUALITY ASSURANCE

A. Qualifications:

Installer Qualifications: A company experienced in the assembly and erection of lifts and residential elevators of the type specified; trained and certified by the manufacturer.

Manufacturer Qualifications: A company specializing in the manufacture of residential elevators.

B. Regulatory Requirements: The complete manufacture, fabrication and erecting of the elevator shall be in compliance with all Federal, State and local codes and ordinances. The installer shall verify requirements of the local authority having jurisdiction and shall comply with all local codes and ordinances.

1.08 DELIVERY, HANDLING & STORAGE

A. All components shall be shipped to the site in substantial crates to protect from damage during shipping and handling. Upon arrival, inspect components and keep under cover until installed.

1.09 WARRANTY

A. Unit shall have a three (3) year limited parts warranty.

1.10 MAINTENANCE

A. Maintenance of the private residential elevator shall consist of regular cleaning and inspection at intervals not longer than every 12 months.

B. Inspection: ASME A17.1 requires all private residential elevators to be inspected every 12 months.

PART 2 PRODUCTS

2.01 MANUFACTURERS

A. Manufacturer: "Destiny" model by The National Wheel-O-Vator Co., Inc.

B. Substitutions: No substitution shall be considered unless written request for approval has been submitted and received by the architect at least ten (10) days prior to the bid date.

2.02 COMPONENTS

A. Car:

1. Size: 36"W x 48"D (others available).
2. Enclosure: Securely fastened to the car frame and platform. The car shall be constructed of a minimum 3/4" wood walls. Floorboard shall be constructed of 1" AC plywood.

3. Gate: Accordion or scissors type equipped with a positively opened mechanical switch to indicate that the door is closed. Scissor type gates shall also be designed to prevent car movement if the gate is moved up or down due to any protruding objects encountering an obstruction.
 4. Handrail: One, located on the car wall.
 5. Telephone: Wall mount telephone jack shipped loose with elevator.
 6. Control panel: Provide one momentary pressure illuminated button for each landing, emergency stop and alarm button, and a digital position indicator; all mounted in a control panel having a stainless steel or brass cover.
 7. Interior lighting: Provide overhead light fixtures that automatically turn on when the car is in operation and turn off by means of a timer circuit.
- B. Hoistway door:**
1. Size: 3'0"W x 6'8"H swing type
 2. The general contractor or owner is to furnish (elevator contractor may opt to furnish) and install hoistway doors, frames, hinges and passage sets at each landing. The type and installation of the doors and frames must comply with ASME A17.1, all local codes and manufacturer's layout drawings.
 3. Locking Device: Door shall have a concealed locking device, interlocked with the car operation, to interrupt electrical power when the door is not securely closed and a car is not at the landing. The door shall be locked when car is not in the landing zone.
- C. Hydraulic power unit:**
1. The pump, submerged motor and valve shall be prewired, ready for connection to the controller in the field.
 2. Up direction acceleration adjustment.
 3. Two speed operation.
 4. Adjustable pressure relief valves.
 5. Manually operated down valve for emergency operation.
 6. Pressure gauges and pressure gauge isolation valves.
 7. Manual valve isolation between pump unit and jack.
 8. Negative pressure switch provided.
 9. Testing: Shall be factory tested prior to shipment.
 10. Muffler provided for quiet operation.
- D. Cylinder:**
1. Construction: Steel pipe with cylinder head having an internal guide ring and self-adjusting packing.
 2. Safety valve: Cylinder shall be equipped with a pipe rupture safety valve to prevent uncontrolled car descent.
- E. Plunger:**
1. Construction: Shall be a machined steel shaft equipped with a stop, electrically welded to bottom end, to prevent plunger from leaving cylinder shaft .
 2. Diameter: 70 or 80 mm, depending on travel distance.
- F. Cable system:** 1:2 system using (2) 3/8" 7x19 aircraft cables integrated with rams header sheave mounted to the plunger.
- G. Guide rail:** Shall consist of two 6 1/4 lb. tee rails assembled and fastened. Provide brackets to hold rail assembly to walls. Rail shall be furnished with steel splice plates and hardware.
- H. Car frame:** Shall be equipped with non-metallic faced roller guide wheels.
- I. Leveling device:** Provide Hall Effect Position Sensor to maintain car within 1/4" of the landing.
- J. Control systems:** Non-selective collective PLC.
- K. Motor (submerged):** 3.0 HP, 1750-RPM 208/230 VAC, single phase.
- L. Wiring:**
1. Provide flexible traveling cable for electrical lights and controls in car.
 2. All other electrical wiring shall be insulated, flame retardant and moisture proof copper wiring, installed in flexible metal conduit.
- M. Safety devices:**
1. Slack cable protection: Provide a stainless steel linkage device that stops and sustains the car in the event of breakage or slackening of cables.
 2. Terminal stopping device: Shall be provided at the top and bottom of the car travel.
 3. Provide a platform toe guard at the car entrance.
- N. Battery emergency operation system:**
1. Powers a light in the car.
 2. Powers an emergency alarm system.
 3. Powers a system to allow car to descend to floor selected by passenger.
 4. The batteries shall be a rechargeable type complete with an automatic recharging system.
- O. "Self Diagnostic System"** utilizing diagnostic codes displayed in hall and car acknowledgement lights to provide information in the event the elevator will not operate.
- ### 2.03 ACCESSORIES
- Specifier Note: Due to the individual nature of elevator installations, accessories such as, but not limited to those in the following list are available:
- A. Hoistway doors and door locks.
 - B. Flush mounted telephone box.
 - C. Car door finish and design.
 - D. Car operating panel and hall call finishes.
 - E. Car trim and wood specie.
 - F. Custom platform and car size.
 - G. Finished flooring.
 - H. Hydraulic tank heater.
 - I. Electrical disconnects.
- ## PART 3 EXECUTION
- ### 3.01 INSTALLATION
- A. Inspect the hoistway and determine if the hoistway meets the manufacturer's requirements for clearances and plumb.
 - B. All components shall be assembled and erected in strict compliance with manufacturer's printed instructions.
 - C. All wiring shall be in accordance with the wiring diagram furnished by the manufacturer.
- ### 3.02 FIELD QUALITY CONTROL
- A. Static/Running Load Test: All load rating and safety factors shall meet or exceed those specified in ASME A17.1.
- ### 3.03 ADJUSTING
- A. Test the elevator to assure proper operation under all conditions of use. Make proper adjustments and review operating components for proper operation.

PART 1 GENERAL

1.01 SECTION INCLUDES

A. Residential elevator with inverter controlled winding drum.

1.02 WORK INCLUDED

A. Furnish all labor and materials, equipment and incidentals necessary to assemble and erect a residential elevator, complete with a power unit and all rails, brackets, connections and controls essential for proper operation.

1.03 WORK BY OTHERS

A. Construct a hoistway of the size required by the manufacturer, complete with all demolition, additional framing, headers and framing components necessary to prepare the existing building to receive the elevator.

1. Hoistway size: Dependent upon car size.
2. The hoistway shall be vertical to within 1/8" throughout the entire height.
3. Provide and fasten vertical structural members in hoistway per manufacturer's recommendation.
4. Pit requirements: Provide an 8" deep pit (6" deep minimum). Install reinforcement and concrete as necessary. Floor must sustain load specified in job drawings.

B. Construct a machine room:

1. Provide elevator electrical circuit: 230 volt/1 phase/60hz (30 amp).
2. Provide elevator lighting electrical circuit: 115 volt (15 amp).

C. Provide system to maintain hoistway and machine room temperature between 50-90 degrees Fahrenheit.

1.04 REFERENCES

A. General: The applicable provisions of the following standards shall apply as if written here in their entirety.

B. American Society of Mechanical Engineers/American National Standards Institute (ASME/ANSI) publications: ASME/ANSI A17.1 "Safety Codes for Elevators and Escalators", Section 5.3.

C. National Fire Protection Association (NFPA) publications: NFPA 70 National Electrical Code.

1.05 SYSTEM DESCRIPTION

- A. Travel: _____ (50' max.)
- B. Stops: _____ (up to 6)
- C. Load capacity: 950 lb. (750 lb. opt.)
- D. Speed: 36 fpm

1.06 SUBMITTALS

A. Submittals shall be in accordance with Section 01300, SUBMITTALS.

B. Product Data: Submit product data, including manufacturer's specifications.

C. Shop Drawings:

1. Shop drawings showing all field construction, including dimensions.

2. Hoistway dimensions.
3. Wiring diagrams.
4. Maintenance instructions.
5. Car and gate selection charts.

1.07 QUALITY ASSURANCE

A. Qualifications:

Installer Qualifications: A company experienced in the assembly and erection of lifts and residential elevators of the type specified; trained and certified by the manufacturer.

Manufacturer Qualifications: A company specializing in the manufacture of residential elevators.

B. Regulatory Requirements: The complete manufacture, fabrication and erecting of the elevator shall be in compliance with all Federal, State and Local codes and ordinances. The installer shall verify requirements of the local authority having jurisdiction and shall comply with all local codes and ordinances.

1.08 DELIVERY, HANDLING & STORAGE

A. All components shall be shipped to the site in substantial crates to protect from damage during shipping and handling. Upon arrival, inspect components and keep under cover until installed.

1.09 WARRANTY

A. Unit shall have a three (3) year limited parts warranty.

1.10 MAINTENANCE

A. Maintenance of the private residential elevator shall consist of regular cleaning and inspection at intervals not longer than every 12 months.

B. Inspection: ASME A17.1 requires all private residential elevators to be inspected every 12 months.

PART 2 PRODUCTS

2.01 MANUFACTURERS

A. Manufacturer: "Destiny" model by The National Wheel-O-Vator Co., Inc.

B. Substitutions: No substitution shall be considered unless written request for approval has been submitted and received by the architect at least ten (10) days prior to the bid date.

2.02 COMPONENTS

A. Car:

1. Size 36"W x 48"D (others available)
2. Enclosure: Securely fastened to the car frame and platform. The car shall be constructed of a minimum 3/4" wood walls. Floorboard shall be constructed of 1" AC plywood.
3. Gate: Accordion or scissors type equipped with a positively opened mechanical switch to indicate that the door is closed. Scissor type gates shall also be designed to prevent car movement if the gate is moved up or down due to any protruding objects encountering an obstruction.
4. Handrail: One, located on the car wall.
5. Telephone: Wall mount telephone jack shipped loose with elevator.

6. Control panel: Provide one momentary pressure illuminated button for each landing, emergency stop and alarm button, and a digital position indicator; all mounted in a control panel having a stainless steel or brass cover.
7. Interior lighting: Provide overhead light fixtures that automatically turn on when the car is in operation and turn off by means of a timer circuit.
- B. Hoistway Door:
1. Size: 3'0"W x 6'8"H swing type.
 2. The general contractor or owner is to furnish (elevator contractor may opt to furnish) and install hoistway doors, frames, hinges and passage sets at each landing. The type and installation of the doors and frames must comply with ASME A17.1, all local codes and manufacturer's layout drawings.
 3. Locking Device: Door shall have a concealed locking device, interlocked with the car operation, to interrupt electrical power when the door is not securely closed and a car is not at the landing. The door shall be locked when car is not in the landing zone.
- C. Drive System:
1. Two speed inverter controlled winding drum unit. A single phase input, three phase output for soft start and soft stop.
 2. The drum motor and inverter shall be prewired, ready for connection to the controller in the field.
 3. Electromechanical broke with manual release.
 4. Testing: Shall be factory tested prior to shipment.
- D. Cable System: (2) 3/8" 7x 9 aircraft wire rope.
- E. Guide Rail: Shall consist of two 6 1/4 lb tee rails assembled and fastened. Provide brackets to hold rail assembly to walls. Rail shall be furnished with steel splice plates and hardware.
- F. Car Frame: Shall be equipped with non-metallic faced roller-guide wheels.
- G. Leveling Device: Provide Hall Effect Position Sensor to maintain car within 1/4" of the landing.
- H. Control Systems: Non-selective collective PLC.
- I. Motor: 3 HP, 1750-RPM 208/230 VAC, three phase.
- J. Wiring:
1. Provide flexible traveling cable for electrical lights and controls in car.
 2. All other electrical wiring shall be insulated, flame retardant and moisture proof copper wiring, installed in flexible metal conduit.
- K. Safety Devices:
1. Slack cable protection: Provide a stainless steel linkage device that stops and sustains the car in the event of breakage of slacking of cables.
 2. Terminal stopping device: Shall be provided at the top and bottom of the car travel.
 3. Provide a platform toe guard at the car entrance.
 4. Final limits.
- L. Manual operation hand wheel is provided.
- M. "Self Diagnostic System" utilizing diagnostic codes displayed in hall and car acknowledgement lights to provide information in the event the elevator will not operate.

2.03 ACCESSORIES

Specifier Note: Due to the individual nature of elevator installations, accessories such as, but not limited to those in the following list are available.

- A. Hoistway doors and door locks.
- B. Flush mounted telephone box.
- C. Car door finish and design.
- D. Car operating panel and hall call finishes.
- E. Car trim and wood specie.
- F. Custom platform and car size.
- G. Finished flooring.
- H. Electrical disconnects.

PART 3 EXECUTION

3.01 INSTALLATION

- A. Inspect the hoistway and determine if the hoistway meets the manufacturer's requirements for clearances and plumb.
- B. All components shall be assembled and erected in strict compliance with manufacturer's printed instructions.
- C. All wiring shall be in accordance with the wiring diagram furnished by the manufacturer.

3.02 FIELD QUALITY CONTROL

- A. Static/Running load test: All load rating and safety factors shall meet or exceed those specified in ASME A17.1.

3.03 ADJUSTING

- A. Test the elevator to assure proper operation under all conditions of use. Make proper adjustments and review operation components for proper operation.

**National
Wheel-O-Vator**

509 W. Front Street
Roanoke, IL 61561-0348
888-353-8898
www.wheelovator.com

Your Authorized National Wheel-O-Vator Dealer: